

ENVIRONMENTAL HEALTH & SAFETY

UNIVERSITY *of* WASHINGTON

# UW CRANE, HOIST AND RIGGING SAFETY PROGRAM MANUAL

---

AUGUST 2023



# TABLE OF CONTENTS

---

TABLE OF CONTENTS .....	2
PURPOSE .....	4
SCOPE .....	4
ROLES AND RESPONSIBILITIES .....	6
TYPES OF OVERHEAD CRANES AND HOISTS .....	8
OVERHEAD OR GANTRY CRANES .....	8
Bridge crane.....	8
Single Monorail Crane.....	8
Portable Gantry Crane .....	9
Jib Cranes .....	9
Other Cranes .....	9
HOISTS .....	10
Manual .....	10
Powered .....	10
CONTROLS.....	11
EQUIPMENT DESIGN FOR MATERIAL HANDLING.....	11
CRANE AND HOIST SAFE OPERATING PROCEDURES.....	12
BEFORE OPERATING HOIST.....	12
APPLYING THE LOAD .....	13
MOVING THE LOAD.....	13
PARKING THE LOAD .....	14
CRANE AND HOIST INSPECTIONS.....	15
PRE-USE INSPECTIONS.....	15
Workplace visual inspection.....	15
Crane, hoist, and rigging inspections .....	16
Crane/hoist operation.....	16
FREQUENT (MONTHLY) INSPECTIONS.....	16
PERIODIC (ANNUAL) INSPECTIONS.....	17
TAGGING OUT OF SERVICE.....	17

TESTING .....	17
CRANE AND HOIST MAINTENANCE AND REPAIR .....	18
RIGGING .....	18
SIMPLE OR ROUTINE LIFTS .....	19
Basic rigging safety.....	19
CRITICAL LIFTS .....	20
RIGGING COMPONENTS.....	21
Slings .....	21
Hardware .....	22
SAFE OPERATING PROCEDURES .....	23
RIGGING INSPECTIONS.....	23
CONTRACTORS .....	24
INCIDENT REPORTING.....	24
PROGRAM AUDITS AND INSPECTIONS .....	25
TRAINING.....	25
Refresher Training.....	26
RECORDKEEPING .....	26
REFERENCES.....	26
APPENDIX A: DEFINITIONS.....	27
DEFINITIONS.....	27
APPENDIX B: OVERHEAD CRANE AND HOIST INSPECTION CHECKLIST .....	29
APPENDIX C: RIGGING EQUIPMENT INSPECTION CHECKLIST .....	33
APPENDIX D: CRANE/HOIST AND RIGGING CRITICAL LIFT PLAN .....	40
APPENDIX E: RIGGING INSPECTION DETAILS .....	42
APPENDIX F: CRANE OPERATOR ASSESSMENT FORM .....	48
APPENDIX G: SUPPLEMENTAL CRANE, HOIST AND RIGGING PROGRAM TEMPLATE.....	49
APPENDIX H:.....	56
STANDARD HAND SIGNALS FOR CRANES .....	56
Hand signal descriptions .....	56

## PURPOSE

---

This document represents the University of Washington (UW) Crane, Hoist, and Rigging Safety Program Manual. The purpose of this program manual is to establish requirements to ensure the safety of personnel and prevent personal injury or illness that could result during the use of overhead cranes, hoists, and the rigging of loads. The requirements in this manual meet the requirements of the [Washington Administrative Code \(WAC\) Section 296-24-235 Overhead and gantry cranes](#), [Section 296-24-237 Construction, operation, and maintenance—Chain and electric hoists](#), [Section 296-24-238 Air Hoists](#), and [Section 296-24-294 Rigging](#).

The intent of this document is to fulfill the following requirements:

- Scope, purpose, employee authorization, requirements, and procedures to ensure safe handling of materials when operating an overhead crane and/or hoist
- Defining types of cranes and hoists operated across campus
- Define the requirements for proper rigging
- Define the requirements for inspection, testing, and maintenance of cranes, hoists, and rigging equipment
- Identify training for operators of cranes, hoists, and rigging
- Provide guidance for UW personnel when managing contractors working with cranes and hoists on UW property, owned or leased

## SCOPE

---

The UW Crane, Hoist, and Rigging Safety Program applies to all University personnel, researchers, and students who are designated to operate cranes, hoists, and rigging equipment for the purpose of work, research, and academics. **Cranes and hoists that are designed to support the building infrastructure and maintenance are the responsibility of facility management.** This includes all locations that serve as assigned workplaces and educational settings for University personnel, including the Seattle, Bothell and Tacoma campuses, the University of Washington Medical Center, Harborview Medical Center, as well as all other University owned properties, University leased spaces, temporary field locations, and research vessels owned or leased by the UW.

This document does *not* cover crane and hoist operations regulated under the Washington Industrial Safety & Health Act (WISHA) [Safety Standards for Construction Work](#) or the following additional cranes:

- Overhead Cranes with Cabs
- Mobile Cranes (Vehicle mounted)
- Patient Lift Devices covered under RCW 70.41.390



Notes:

- *UW departments, units, and organizations can use the UW Crane, Hoist, and Rigging Program Manual to meet compliance requirements. Departments/units/organizations may develop and require specific procedures, equipment, and documentation for managing their own crane/hoist program. This department/unit/organization-specific information with details may be added as an addendum to this program manual if the requirements are equal to or more stringent and do not conflict with the information provided in this document.*
- *For the purposes of this document, “employees” refers to University personnel (as defined in Administrative Policy Statement [40.1](#)), faculty, staff, paid student workers, contractors, and vendors*

## ROLES AND RESPONSIBILITIES

Role	Responsibilities
Departments/Units/ Organizations	<p>Departments/units/organizations that own, use, and operate cranes, hoists, and rigging equipment.</p> <ul style="list-style-type: none"> <li>• Provide necessary resources to implement, maintain, and document department-specific crane, hoist, and rigging safety procedures.</li> <li>• Ensure purchased, acquired, or built equipment is compliant with the requirements of this manual.</li> <li>• Identify a designated person to oversee the department specific crane, hoist, and rigging program within their department/unit/organization (Refer to Appendix G).</li> <li>• Provide training to the designated person by a person/company qualified to train assigned crane/hoist operators.</li> <li>• Ensure crane and hoist operators are trained by a competent person on proper use and operation of cranes and hoist and safe rigging practices.</li> <li>• Ensure contractors adhere to crane, hoist, and rigging safety requirements outlined in this manual.</li> <li>• Report incidents to EH&amp;S within 24 hours via the <a href="#">UW Online Accident Reporting System (OARS)</a>. Some incidents require <a href="#">immediate notification</a>.</li> </ul>
Environmental Health & Safety (EH&S)	<ul style="list-style-type: none"> <li>• Develop, coordinate, and maintain the UW Crane, Hoist, and Rigging Safety Program in accordance with WAC 296-24 Part D.</li> <li>• Assign a UW Crane, Hoist, and Rigging Safety Program Administrator to maintain the overall program.</li> <li>• Provide consultation and assistance to departments to comply with the requirements of this program.</li> <li>• Conduct periodic shop inspections which include programmatic inspection questions related to cranes, hoists, and rigging equipment.</li> <li>• Perform an annual review of the UW Crane, Hoist and Rigging Safety Program for accuracy and ensuring compliance with regulatory requirements and current industry best practices.</li> <li>• Audit a representative sample of department/unit/organization procedures to ensure compliance in accordance with this manual.</li> </ul>
Crane/Hoist Operators	<p>Authorized crane, hoist, and rigging operators that are 18 years old or greater and have been designated to operate the crane and hoist by the department/unit or organization</p> <ul style="list-style-type: none"> <li>• Identified by the department/unit/organization to be a crane/hoist operator.</li> <li>• Trained and evaluated as competent to operate cranes, hoists, and rigging equipment in a safe manner.</li> <li>• Perform pre-use inspections.</li> <li>• Document monthly inspections.</li> <li>• Report all maintenance/repair issues to their supervisor and removes defective equipment and tags out of service.</li> <li>• Report all incidents to their supervisor immediately.</li> </ul>

Role	Responsibilities
Crane/Hoist Competent Person	<p>A UW crane operator or a person that has been designated to oversee the unit/department crane, hoist, and rigging program and will provide crane/hoist training to other employees identified to be crane/hoist operators</p> <ul style="list-style-type: none"> <li>• Develops and maintains the unit/department crane, hoist, and rigging program.</li> <li>• Trained by a <b>qualified person</b> on the operation, maintenance and inspection of cranes, hoists, and rigging equipment.</li> <li>• Trained by a <b>qualified person</b> to train crane operators and is designated by their management to provide crane training to the crane operators on unit/department specific equipment.</li> <li>• Evaluates and verifies the proficiency and skills of the crane operators.</li> <li>• Revokes crane operator authorization, if required.</li> </ul>
Qualified Crane/Hoist/Rigging Company/Person	<p>A third-party company or person (representing UW) that is <b>qualified</b> to design, install, maintain, and test cranes, hoists, and rigging equipment</p> <ul style="list-style-type: none"> <li>• Provides competent person training for designated persons.</li> <li>• Provides annual preventive maintenance and periodic inspections of cranes and hoists.</li> <li>• Provides testing of new, altered, or repaired cranes and hoists.</li> </ul>
Project Managers (hiring managers)	<ul style="list-style-type: none"> <li>• Project managers (hiring managers) must coordinate and discuss with contractors the scope of work for material handling operations where a crane/hoist is operated, repaired, maintained, and tested.</li> <li>• Ensure any accidents or incidents related to crane/hoist operations are reported to the <a href="#">UW Online Accident Reporting System (OARS)</a>.</li> </ul>

# TYPES OF OVERHEAD CRANES AND HOISTS

## OVERHEAD OR GANTRY CRANES

The UW has many different types of overhead or gantry cranes with hoists that run along monorails or bridge trolleys. The main components are comprised of trolleys that travel along monorails, bridge girders or jibs, hoists with wire rope or chain, and a load hook. The design and construction of these types of cranes must be in accordance with the American National Standards Institute (ANSI) B30.2.0 Safety Code for Overhead and Gantry Cranes.

These types of overhead cranes have requirements for ladders and stairways to access their girders and rails, bridge and trolley bumpers, braking systems, hoists, electrical components and safety devices (e.g., warning devices, emergency stops, limit switches, etc.).

### Bridge crane

A bridge crane consists of girders, trolleys, and hoist(s) where the hoist travels on overhead rails that are part of the permanent building structure.

There are single and double girder overhead cranes that can have the hoist on top of the girder or they can be mounted underneath (underhung cranes).



*Figure 1: Double girder bridge crane with trolley mounted underneath*



*Figure 2: Double girder bridge crane with trolley mounted on top of girders*

### Single Monorail Crane

A monorail crane lifts, lowers, or suspends materials across a fixed path horizontally. It relies on a track system with a trolley attached to a manual or powered hoist. The monorail can be straight or curved. A pendant is used to control the powered hoist from the floor or platform.

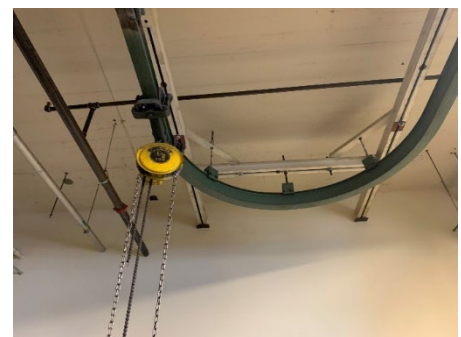

*Figure 3: Monorail crane with manual chain hoist*

## Portable Gantry Crane

Portable gantry cranes are used across the University for lifting operations in interior and exterior locations. These are overhead cranes supported by a mobile frame which travels on the ground. Hoist attachments are typically manual chain hoists but can be attached to powered hoists.



Figure 4: Portable gantry crane with manual chain hoist

## Jib Cranes

Jib cranes, typical at the UW, can be floor mounted or wall mounted. They can have manual or powered hoists mounted on a trolley or can have hoists without the use of a trolley.

Wall-supported jib cranes can be used with manual or powered hoisting equipment. The hoists shall be designed in accordance with American Society of Mechanical Engineers (ASME) B30.16 Overhead Hoists (underhung).

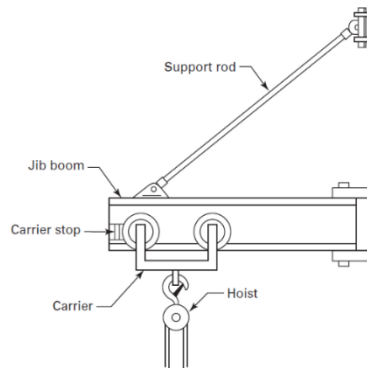

Figure 5: graphic of a jib crane with trolley and hoist



Figure 6: Floor mounted jib crane

## Other Cranes

**Vessels** – Cranes and hoists can be installed on research vessels. The operation of these cranes and hoists must be in accordance with this manual in addition to the requirements for safe operation of cranes from the [University National Oceanographic Laboratory System Research Vessel Safety Standards](#).

For more information refer to the [UW Boating Safety Manual](#).

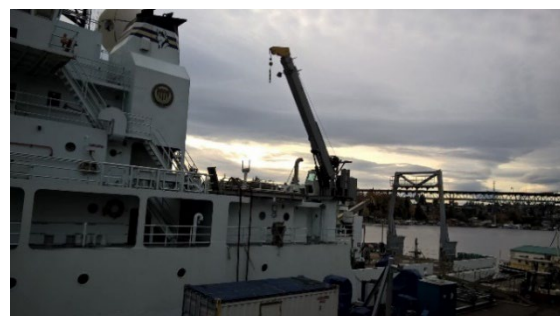

Figure 7: Research Vessel mounted overhead Crane and hoist

## HOISTS

Hoists can be manual, electrical, or pneumatic and attached to a fixed location, or travel on a motorized or push trolley when part of an overhead or gantry crane. Hoists raise and lower loads vertically.

Hoist components consist of:

- Upper hook – The hook that attaches the hoist to its support system (crane or beam)
- Lower hook – The hook that attaches to the load that requires lifting
- Hook latch – A safety mechanism that locks the hook onto its attachment
- Load chain/rope/wire rope – Connects the lower hook to the lifting mechanism
- Drum & rope guide – Guides and wraps the chain/rope as it lifts/lowers its load
- Lifting/lowering mechanism – The gear and pulley mechanism
- Hoist frame – Contains the lifting mechanism.

### Manual

Manual hoists can be chain or wire rope driven and are attached to a trolley or anchor point. The anchor point must be designed with a 5:1 safety factor to support the safe working load (i.e., maximum working load). For example, if the safe working load of the hoist is 1,000 lbs. the anchor point shall be designed to withstand 5,000 lbs.



### Ratchets and Come Alongs

These are similar to manual chain hoists; however, they are typically used to pull a load, using a lever, in different directions where hoists are limited to up and down. This manual provides requirements for these devices when used to move loads vertically.

*Figures 8a and 8b: Manual rope and chain hoists (above) and Ratchet hoist (right) from Grainger*



### Powered

**Electric** powered hoists can be attached to a trolley that is powered or manual. These can be wire rope or chain hoists.



*Figure 9: Dayton electric chain hoist*



*Figure 10: OZ electric wire hoist with pendant*



**Pneumatic** driven hoists are powered by compressed air. **Air hoists** can be suitable for continuous operation and for locations that are electrically classified areas (flammable or combustible dusts).



Figure 11: Air - Pneumatic hoist (UW installation)

## CONTROLS

Controls for powered cranes and hoists can be wall mounted, pendant, or remote. All controls and controllers must be clearly marked as to the function and direction of travel.

All controllers must have a stop or E-stop button on them.

The push button, once released, must immediately stop the movement of the crane/hoist.

**Pendant controls** are typically used to operate powered cranes and hoists.

Pendants can be designed to be operated from the floor or platform and must be located so the operator can be a safe distance away from the load.

Pendant controls must have a support cable, separate from the power cord (can be internal inside the cord on smaller remotes).

**Radio controls** are comprised of a transmitter and receiver.

If radio remote controls are being used, the radio remote should have a visible indicator showing they are actively engaged with the crane.

Radio remote operated cranes must stop if the signal is lost.



Figure 12: Wall Controls (UW installation)



Figure 13: Pendant Controls (UW installation)

## EQUIPMENT DESIGN FOR MATERIAL HANDLING

- The design of all cranes and hoists must comply with the requirements of ASME/ANSI B30 standards and Crane Manufacturers Association of America (CMAA) standards.
- The type of crane and hoist must be selected based on the anticipated loads handled and frequency of use.
- Design load pathways are separate from personnel walkways or egress pathways.

- Crane pendants must have an electrical disconnect switch or button to open the main-line control circuit that is readily accessible per the National Fire Protection Agency (NFPA) 70, National Electric Code. The disconnect must be designed to accept an Occupational Safety and Health Administration (OSHA) approved locking device.
- Cranes and hoists must have a main electrical disconnect switch. This switch must be in a separate box that is labeled with lockout capability.
- Crane bridges and hoist monorails must be labeled on both sides with the maximum load capacity. If the crane has more than one hoisting unit, each hoist must have its rated load marked on the hoist or its load block so that the rated load marking must be legible from the ground or floor. The combined load on all hoists on the crane must not exceed the rated load of the crane.
- All crane and hoist hooks must have safety latches.
- For bridge cranes with multiple directions, directional signs indicating N-W-S-E must be displayed on the bridge underside, and a corresponding directional label must be placed on the pendant.
- A device such as an upper-limit switch or slip clutch must be installed on all building cranes and hoists. A lower-limit switch may be required when there is insufficient hoist rope on the drum to reach the lowest point. There must be a least two wraps of rope around the hoist drum where the hook is at the lowest position.
- All newly installed cranes and hoists, or those that have been extensively repaired or rebuilt structurally, must be load tested at 125% rated capacity prior to being placed into service.

## CRANE AND HOIST SAFE OPERATING PROCEDURES

---

The following information provides general guidance for the safe operation of crane and hoists. Units/departments are required to develop equipment-specific standard operating procedures to supplement the instructor-led training provided to crane operators. The standard operating procedures must address the safeguards required to reduce or eliminate the hazards/risks associated with operating a crane and/or hoist and rigging the load. A job hazard analysis (JHA) can be used in place of the SOP if the content provides equipment-specific instructions on the hazards and controls required to manage the potential risks during specific crane/hoist operations. Refer to [Appendix G: Supplemental Program Template](#) for more information on what is required.

### BEFORE OPERATING HOIST

- The operator must be familiar with all operating controls of the hoist and be instructed in the operation(s) to be performed. Instructions must include, as applicable, the warnings on the hoist, the hoisting practices listed in this section and the operation instructions portion of the hoist manufacturer's manual.



- If adjustments or repairs are necessary, or any defects are known, the operator must report this promptly to their supervisor.
- The operator must not operate a hoist that bears an out-of-order/out-of-service sign or tag.
- The operator must not adjust or repair a hoist unless qualified. The chain or rope must not be used as a ground for welding.
- A welding electrode must not be touched to the chain or rope.
- Hand chain-operated hoists must only be operated with hand power, with no more than one operator per hand chain.
- The operator must conduct the pre-use inspection in accordance with the criteria outlined in the [Pre-Use Inspections section](#) of this manual.

## APPLYING THE LOAD

- The hoist rope or chain must not be wrapped around the load.
- The load must be attached to the load hook by an appropriate load rated attachment.
- The sling or other device must be properly seated in the base (bowl or saddle) of the hook. The hook latch must not be allowed to support any part of the load.
- The load must not be applied to the point of the hook.
- Before moving the load, the operator must be sure chains or wire rope rigging are not kinked or twisted or that multiple part chains or ropes are not twisted about each other.
- The hoist must not be operated unless the rope or chain is seated properly on the drum, sheaves, or sprockets.
- Hoists must not be operated unless the hoist unit is centered over the load (side pulls are prohibited), except when authorized by a qualified person who has determined that the components of the hoist and its mounting will not be overstressed. Should it be necessary to pick a load that is not centered under the hoist unit, precautions must be taken to control the swing of the load when it is picked up clear of its support.
- The operator must not pick up a load in excess of the rated load appearing on the hoist or load block, except during properly authorized tests. A hoist overload limiting device must not be used to measure the maximum load to be lifted.
- Specific attention should be given to balancing the load and hitching or slinging to prevent slipping of the load.

## MOVING THE LOAD

- The operator must not engage in any activity that will divert the operator's attention while operating the hoist.

- The operator must respond to signals from a designated person only. However, the operator must obey a stop signal at all times, no matter who gives it. Refer to [Appendix H](#) for crane hand signals.
- The operator must not lift or lower a load with the hoist until the operator and all other personnel are clear of the load.
- The operator must make sure the load and hoist will clear all obstacles before moving or rotating the load.
- The hoist must be centered over the load to ensure a vertical lift.
- The operator must inch powered hoists slowly into engagement with a load but should avoid unnecessary inching and quick reversals of direction.
- A load must not be lifted more than a few inches until it is well balanced in the sling or lifting device. If the load needs to be rebalanced, lower it back to the ground and adjust the load.
- Each time a load approaching 75% of the rated load capacity is handled, the operator must check hoist brake action by lifting the load just clear of supports and continuing only after verifying that the brake system is operating properly. If the lift is at or greater than 75% of the rated load capacity, the lift is considered a critical lift and must be in accordance with the requirements in the [Critical Lift Section](#).
- On rope hoists, the load must not be lowered below the point where less than two wraps of rope remain on each anchorage of the hoist drum, unless a lower limit device is provided. Under these circumstances, no less than one wrap may remain on each anchorage of the hoist drum.
- The operator must avoid carrying loads over people.
- Personnel must not be carried on the hook or the load.
- The operator must avoid swinging the load or load hook when traveling the hoist. A tag line can be used to control the swing of the load, if necessary.
- On trolley-mounted hoists, contact between trolleys, or between trolleys and stops, should be avoided.
- The operator must not use the upper (or lower, if provided) limit device(s) as a normal means of stopping the hoist. These are emergency devices only.

## **PARKING THE LOAD**

- The operator will not leave a suspended load unattended unless specific precautions have been instituted and are in place.
- Position the load over the set-down location and slowly lower the load. Taglines can be used to position the load while keeping the operator at a safe distance.

- Stop the crane when the load block is low enough to unhook the sling or rigging equipment. Care must be exercised when removing a sling from under a landed and blocked load.
- The load block will be positioned above head level for storage when the hoist is not in use.
- Turn all controllers to the “off” position.

## CRANE AND HOIST INSPECTIONS

---

Crane and hoist inspection and maintenance are essential to safe equipment operation. Operator safety can be improved, and operator injury can be avoided if the equipment is properly inspected and maintained. Failure to complete overhead crane and hoist inspections and proper equipment maintenance could lead to serious injury, death, or destruction of property.

There are two types of inspections.

**Frequent inspection** – daily to monthly, performed by the operator.

A frequent inspection is required for cranes and hoists that are in regulator use or have been idle from 1 to 6 months. The monthly inspection must be documented and signed and dated by the operator.

**Periodic inspection** – annual inspection (can be more frequent for heavy use and harsh conditions) performed by a qualified person or company.

Typically, a third-party crane company is used to perform these more thorough inspections. All cranes and hoists that are in regular use or have been idle for greater than 6 months are required to undergo a periodic inspection. The inspection must be documented and signed and dated by the inspector.

## PRE-USE INSPECTIONS

Under the regulation [WAC 296-24-23519](#), overhead cranes and hoists must be inspected before use.

The operator or other designated person conducts the inspection. Cranes, hoists, and rigging equipment must be inspected before use. These inspections do *not* have to be documented. The pre-operational inspection should include:

- Inspection of the workplace
- Inspection of the crane, hoist, and rigging equipment
- Functional check of the crane/hoist operations

### Workplace visual inspection

Ensure the following:

- Overhead obstructions in the path of travel, during loading and unloading, are not present.
- There are no other overhead cranes on the same rails or in the same proximity.
- The load will not be lifted over people or pathways that serve as an exit pathway, unless access has been restricted with barriers/signage.
- The working/walking surface underneath the travel path is clean, dry, and free of tripping hazards.
- The location where the load will be transported to can safely handle the maximum load capacity.

### **Crane, hoist, and rigging inspections**

Utilize the frequent (monthly) inspection checklists for crane/hoists ([Appendix B](#)) and rigging equipment ([Appendix C](#)) as a guide during the visual inspection of the condition of the crane, hoist, and rigging equipment.

- Visually inspect the hook, load lines, trolley, and bridge as much as possible from the operator's station; in most instances, this will be the floor of the room or area.
- Visually inspect the condition of the pendant, if applicable.
- Visually inspect below the hook rigging equipment.

### **Crane/hoist operation**

Perform the following functional checks without a load.

- Test the upper-limit switch. Slowly raise the unloaded hook block until the limit switch trips.
- If provided, test the lower-limit switch.
- Test all direction and speed controls for both bridge and trolley travel.
- Test all bridge and trolley limit switches, where provided, if operation will bring the equipment in close proximity to the limit switches.
- Test the pendant emergency stop.
- Test the hoist brake to verify there is no drift without a load.
- If provided, test the bridge movement alarm.

## **FREQUENT (MONTHLY) INSPECTIONS**

Operators must perform a monthly inspection of the crane and hoist and document the inspection on the monthly inspection checklist ([Appendix B](#)).

Any deficiencies must be documented on the inspection checklist, and the crane or hoist must be taken out of service until the deficiencies have been addressed.

During the inspection, if the operator cannot visually inspect any of the components, the crane and hoist must be taken out of service until the inspection can be completed.

## PERIODIC (ANNUAL) INSPECTIONS

**Periodic Inspections** must be completed by qualified personnel. Overhead cranes and hoists in regular use must have a periodic inspection at least **annually**. Refer to the [Cranes, Hoists and Rigging Safety webpage](#) on the EH&S website for more information on periodic inspections and a list of local crane inspection firms with qualified personnel.

During the inspection, if the inspector cannot visually inspect any of the components, the crane and hoist must be taken out of service until the inspection can be completed.

Any overhead cranes/hoists with deficiencies identified during an inspection must be tagged “out of service,” repaired, or corrected before use.

## TAGGING OUT OF SERVICE

During an inspection, if any component is determined to be defective or unsafe, the crane must be taken out of service and an “out of service” or “out of order” sign shall be located beneath or on the hook such that it is visible from the floor.

When the crane or hoist is being serviced or repaired, the power source(s) for the crane or hoist must be locked and tagged out per the UW [Hazardous Energy Control Program](#) requirements. Do not use the lockout-tagout locks and tags for cranes/hoists that are out of service or order unless they are being serviced or repaired.

In cases where there are adjacent cranes in use, the unit/department may want to secure the operating controls for the adjacent crane to prevent its operation while maintenance activities are occurring nearby.

## TESTING

---

New and reinstalled cranes and hoists require initial operational and load testing. Testing must be performed by a qualified person.

Operational and load tests must be performed in accordance with [WAC 296-24-23521](#) and ASME B30.11 and B30.16.

Extensively repaired and altered cranes and monorails must be load tested. Tests may be limited to the functions affected by the alteration, repair, or modification, as determined by a qualified person.

All tests must be documented and kept on file per the [recordkeeping section](#) of this manual.

Portable hoists and ratchets or “come alongs” used for vertical lifting can be exempted from a field load test if the following are provided:

- Manufacturer’s proof load test certificate
- Qualified person’s verification of a 5:1 safety factor of anchor or support attachment for hoist

## CRANE AND HOIST MAINTENANCE AND REPAIR

---

Each department or unit must establish a preventive maintenance program for the crane and hoist that is based on the manufacturer's recommendations.

All active cranes and hoists must have regular preventive maintenance performed in accordance with the manufacturer's recommendations.

During repair and maintenance activities follow the requirements for tagging out of service.

All adjustments and repairs must be performed by qualified personnel.

Following repair, the crane and hoist guards, all safety devices removed or inactivated must be reinstalled and activated, respectively, and all maintenance tools must be removed.

All cranes and hoists that have been repaired must be tested in accordance with the requirements in the [Testing](#) section of this manual.

Ensure the crane trolley and hoist are run to a position where there will be no interference with other cranes or operations within the room or area.

## RIGGING

---

Rigging is a critical part of material handling when using cranes and hoists. Improper rigging can lead to potential failures resulting in personal injury and property damage. Operators using cranes and hoists must be trained in safe rigging and understand the hazards, failure modes, and consequences associated with improper rigging.

Important factors to consider when rigging include the:

- Weight of the load and rigging hardware  
Information from shipping papers, manufacturer's data, equipment nameplate, or measuring the weight are sources of information to help determine the load weight.
- Capacity of the hoisting device  
Refer to the manufacturer's information for the maximum load capacity of the hoist and the "below the hook" rigging components.
- Sling configuration  
Utilize the safe working load limits for the sling and the type of configuration used.
- Load angle factor and sling tension  
Sling angle can affect the lifting rated capacity. Refer to the manufacturer's information.
- Environmental conditions

Follow the manufacturer’s recommendation for safe temperatures.

- Center of gravity of the load

## SIMPLE OR ROUTINE LIFTS

Simple or routine lifts where the maximum load lifted has been performed repeatedly: if it is not a critical lift and there have been no incidents related to the specific lift, the load can be rigged without documentation.

### Basic rigging safety

Each component used in rigging the load has a maximum load capacity. The safety working load (SWL), or maximum load limit (sometimes called maximum working load) cannot be exceeded.

The configuration of the sling hitch and the hitch angle loading can impact the SWL of the sling.

Types of hitches:

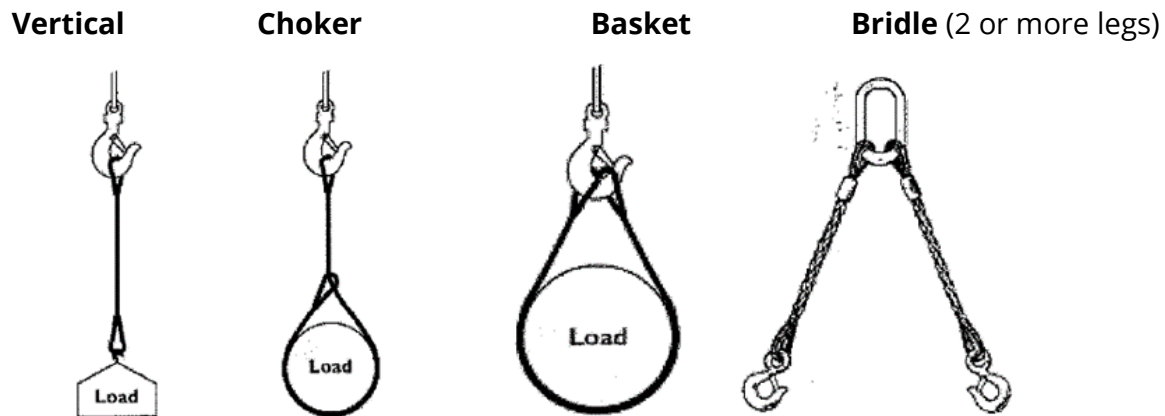

Figure 14: Overton Safety Training manual



Figure 15: Nylon sling with load capacities for different rigging configurations (terranova.co.uk)

It is important to review the load ratings from the manufacturer for the rigging components to determine the safe working load for the rigging configuration selected.



The **vertical single sling hitch** is the most basic configuration and can lift the maximum load rating of the sling. Typically, the sling is attached to the crane or hoist hook and the other end is connected to an attachment on the load. This type of hitch should *not* be used for loads that are loose, long, or unbalanced.

A **choker hitch** is used to tighten or snug the sling down to secure the load, providing better control of the load. One eye of the sling is wrapped around the load and then passed through itself and attached to the crane or hoist hook. Due to stresses created at the choke point, a choker hitch reduces the lifting capacity to 75-80% of what it is capable of in a vertical single sling hitch. The least amount of capacity reduction occurs when the angle of choke is 120° or greater. For choke angles less than 120°, the maximum load capacity can be reduced as low as 40%.

This type of hitch should *not* be used for loose or unbalanced loads. If required, use a double choker hitch to secure the load.

The **basket hitch** cradles the load between the two legs of the sling. The sling can be single or double wrapped around the load. When the sling is at a 90-degree angle to the horizontal surface of the load, the maximum loading rating is increased by 100%. This configuration typically involves the use of a spreader bar or lifting bar.

The maximum load capacity is reduced when the angle of the sling is less than 90 degrees.

Basket hitches should *not* be used for loads that are unbalanced.

A **bridle hitch** with multiple legs is typically used for managing loads that have multiple attachment points. When a single leg is used, the maximum load capacity is at 100%. If the load is rigged using multiple legs, the rated capacity can be affected by the angle and length of the legs. It is important to review the load capacities included with the manufacturer's instructions.

## CRITICAL LIFTS

A critical lift is a lift that meets any of the following criteria:

- Lifting loads over people or an occupied space where personnel could get severely injured.
- Lifting loads where dropping a load would cause a release of hazardous materials, extensive property damage or interrupt business/research operations for one month or more. An example would be a load greater than 1 ton (2000 pounds).
- Lifting loads that weigh 75% or greater of the rated capacity of the crane and/or hoist.
- When more than one crane/hoist is used to lift the load.

When a critical lift is identified, the crane operator must complete the Crane/Hoist and Rigging Critical Lift Plan (refer to [Appendix D](#)).

The critical lift plan must be reviewed and approved by the unit/department management before the lift is conducted.



Any changes to the crane, hoist, or rigging equipment or rigging configuration require the work to be stopped until the critical lift plan has been revised, reviewed, and approved.

## RIGGING COMPONENTS

Rigging equipment refers to all the components used to rig the load below the hook of the hoisting mechanism. When selecting the rigging equipment, the following must be considered:

- Size and shape;
- Weight;
- Temperature and sensitivity; and
- Environmental conditions.

All rigging equipment must have a legible maximum load capacity tag or marking.

### Slings

#### Chain

Chain slings must be made of alloy steel. Chain slings are typically used for rough loads and environmental conditions of high temperatures. Although rugged, a failure in a single chain can result in an accident. Additionally, every single chain needs to be inspected.

The chain sling will have a tag or label with the load different configurations.



Figure 16: Chain and wire rope slings (Grainger)

#### Wire/Rope

Wire rope is very flexible and strong; it can fit snugly around a load and be used in any configuration. It is difficult to inspect and is susceptible to corrosion.

#### Synthetic

Synthetic slings are web and round slings and can be polyester or nylon. These slings are flexible and can easily mold around the load and absorb shock loading. The materials are more susceptible to cuts and abrasions. The type of material selected is important when considering environmental conditions (e.g., flame, welding, temperature, chemicals), as these conditions can affect the sling and reduce the sling's life and strength.



Figure 17: Synthetic slings (Mazzella company)



Figure 18: Metal mesh sling (Grainger)

### Metal Mesh

Metal mesh slings are very durable, flexible and can be used in high temperature environments. These types of slings can be crushed and must be removed from service if one wire breaks.

## Hardware

The rated capacity of each lifting device must be marked on the device where it is visible and legible. If the lifting device comprises of several items, each detachable from the assembly, each item must be marked with its rated capacity.

At a minimum, a nameplate, name tag, or other permanent marker must be affixed displaying the following data:

- Manufacturer or contractor's name if fabricated on-site
- Lifting device weight, if over 100 pounds
- Serial number (if available)
- Rated capacity



Figure 19: Eye bolts (various vendors)

These lifting devices must be used to connect loads below the hook in accordance with their manufacturer's recommendations. Do not exceed the safe working load of the lowest rated component. Some key points regarding hardware include the following:

- Swivel hooks are recommended over eye bolts.
- Shackles should not be allowed to be pulled at an angle.
- Use a shackle when more than two slings are attached to a hook.
- Spreader bars should be used with long loads.
- Eye bolts can have a shoulder or be without a shoulder.
- Shouldered eye bolts should be flush with the surface of the load.
- Consult the manufacturer's instructions to determine the safe working load based on the angle of the sling connection to the eye bolt. Never rig eye bolts with an angle less than 45°.
- Hooks must have a safe working load capacity equal to or exceeding the load rating of the sling or suspension device that it is connected to.
- Hook rated capacities decrease when the load is connected off-center of the hook.
- The hook must be provided with a safety latch.



Figure 20: Spreader bar (Tulsachain.com)



Figure 21: Rigging Hardware (uscargocontrol.com)

- Turnbuckles should only be used if made of forged steel.

## SAFE OPERATING PROCEDURES

Whenever any sling is used, you must observe the following practices:

- Do not use slings that are damaged or defective.
- Ensure slings are not shortened with knots or bolts or other makeshift devices.
- Ensure sling legs are not kinked.
- Do not load a sling in excess of its recommended safe working load as prescribed by the sling manufacturer on the identification markings permanently affixed to the sling.
- Balance the loads of slings used in a basket hitch to prevent slippage.
- Securely attach slings to their loads.
- Ensure slings are padded or protected from the sharp edges of their loads.
- Keep suspended loads clear of all obstructions.
- Ensure all personnel are kept clear of loads about to be lifted and suspended loads.
- Ensure hands or fingers are not placed between the sling and its load while the sling is being tightened around the load.
- Do not engage in shock loading.
- Do not pull a sling from under a load when the load is resting on the sling.
- Do not use slings without affixed and legible identification markings.

## RIGGING INSPECTIONS

All rigging equipment must be inspected by the crane/hoist and rigging operator before use and a formal documented inspection must be performed annually. Refer to [Appendix C](#) for the annual Rigging Equipment Inspection Checklist.

When performing an inspection, each time before use, the crane/hoist and rigging operator must do the following:

- Ensure the rigging equipment is clean of any dirt or grease that could conceal damage before inspecting the equipment.
- Inspect the entire sling and hardware components and remove any rigging equipment that meets the manufacturer's recommendation for excessive wear. Use the Rigging Equipment Inspection Checklist ([Appendix C](#)) as a guide for inspecting the specific rigging equipment.
- Ensure the load capacity tag is present and legible.
- In the event there are any deficiencies, remove the rigging equipment from service immediately and tag it "out of service."

- Do not use any rigging equipment that has been repaired unless repaired and tested by the manufacturer.

## CONTRACTORS

---

Contractors must *not* utilize University owned, leased, or managed crane and hoist equipment unless approved by the organization/unit/department. Crane operations associated with construction projects are covered under construction project requirements and are *not* addressed in this program manual.

Contractors working on UW property (leased or owned) must follow their own Crane, Hoist and Rigging Safety program in accordance with the Washington Industrial Safety & Health Act (WISHA) [296-24 Part D Material Handling and Storage, including Cranes, Derricks and Rigging](#) and the requirements of this manual, where applicable. The UW person responsible for hiring the contractor must request the following documents from the contractor prior to work commencing:

1. The Job Hazard Analysis (JHA) and Lift Plan must be submitted for review for all crane lifts five working days in advance of the lift.
2. Required documents for all crane/hoist lifts
3. Company Crane and Rigging Safety Program
4. Crane and Rigger training records
5. Critical Lift Plan in accordance with the [critical lifts](#) section of this document
6. Inspection records for crane, hoist, and rigging equipment (most recent)

The UW responsible party must have a competent person review and accept the information submitted. Any gaps that are identified must be addressed and resolved by the contractor before work is performed.

## INCIDENT REPORTING

---

UW personnel must report any work-related event that leads to an injury, illness, exposure, fire, property damage or near-miss event to their supervisor as soon as possible. After reporting the incident to a supervisor, submit a report of the incident within 24 hours to EH&S via the [UW Online Accident Reporting System \(OARS\)](#). Some incidents require immediate reporting. Visit the [Incident Reporting webpage](#) on the EH&S website for more information.

UW units and departments must hold personnel accountable for following all safety policies and protocols and ensure they understand the consequences and risks associated with non-adherence to crane, hoist, and rigging safety requirements. Failure to follow the UW Crane, Hoist, and Rigging Program Manual may cause a serious safety violation. Violations of program requirements (including incidents that did *not* result in an accident or

injury) must be documented as a “near-miss” event using the UW EH&S [Online Accident Reporting System \(OARS\)](#).

## PROGRAM AUDITS AND INSPECTIONS

---

Departments/units/organizations must assign a designated person the responsibility of reviewing their crane, hoist, and rigging program annually.

EH&S conducts inspections of cranes, hoists, and rigging equipment during shop inspections; the frequency of the inspections is every two years.

The program audits and inspections performed by EH&S are to be documented and any deficiency assigned a corrective action and communicated to management. Corrective actions must be tracked to completion.

## TRAINING

---

Departments must train personnel in the safe operation of cranes and hoists, and how to properly rig loads.

It is recommended that each department/unit identify and train a designated person to train others in their department/unit on how to safely operate the cranes and hoisting equipment. The designated trainer must be a competent person and have completed crane safety training designed to “train the trainer,” from a qualified person (or company).

Each crane, hoist, and rigging operator must be trained on the specific equipment before the operator is allowed to operate the equipment.

The training must consist of a combination of:

1. Completing the [Overhead and Gantry Crane Safety-Online](#), [Rigging Safety-Online](#), and [Lockout-Tagout Refresher-Online](#) (for affected personnel) training courses on the EH&S website.
2. Reviewing the manufacturer’s equipment manual for operation, inspection, and maintenance of the equipment
3. Reviewing the inspection checklists for the cranes and hoist ([Appendix B](#)), and rigging equipment ([Appendix C](#)).
4. Practical training of the operator in the workplace, on specific equipment, by the designated trainer.

The crane/hoist operator can be assessed after completing a written test\* and a performance evaluation on the applicable equipment. The performance assessment is conducted by the crane/hoist competent person and documented using the form in [Appendix F](#).

\*This can be achieved by taking the [Overhead and Gantry Crane Safety-Online](#) and [Rigging Safety-Online](#) training courses on the EH&S website.

## Refresher Training

Refresher training is required:

- When new equipment is planned to be used
- Following an accident or incident
- Performing an unsafe operation (observed)
- When a deficiency related to safe operation is identified during an inspection or audit
- Where a performance evaluation by the trainer indicates deficiencies

## RECORDKEEPING

---

The following records must be retained according to UW policy and regulatory record retention requirements:

Record	Retention Requirement
Inspection records (frequent and periodic)	1 year or until the creation of new one
Maintenance and testing Records	6 years
Program audits and inspections	6 years
Training documents	7 years

## REFERENCES

---

[WAC 296-24 Part D PART D MATERIALS HANDLING AND STORAGE, INCLUDING CRANES, DERRICKS, ETC., AND RIGGING](#)

ASME B30.11-2004 Monorails and Underhung Cranes

ASME B30.16 – 2007 Overhead Hoists (underhung)

## APPENDIX A: DEFINITIONS

---

### DEFINITIONS

**Brake** - A device used for retarding or stopping motion by friction or power means.

**Bridge** - That part of a crane consists of girders, trucks, end ties, footwalks, and drive mechanism which carries the trolley or trollies.

**Bridge (crane) Girder** - Crane member on which carriers travel, horizontally mounted between and supported by the end trucks.

**Bridge travel** - The crane movement in a direction parallel to the crane runway.

**Bumper (buffer)** - An energy absorbing device for reducing impact when a moving crane or trolley reaches the end of its permitted travel; or when two moving cranes or trollies come in contact.

**Competent person** - One who is capable of identifying existing and predictable hazards in the surroundings or working conditions which are unsanitary, hazardous, or dangerous to employees, and who has authorization to take prompt corrective action to eliminate them.

**Competent Trainer** - A designated person that has been trained by a Qualified person/company to provide on-site training for cranes, hoist, and rigging equipment operated by the department/unit/organization.

**Construction work** - All or any part of excavation, construction, erection, alteration, repair, demolition, and dismantling, of buildings and other structures and all operations in connection therewith; the excavation, construction, alteration and repair of sewers, trenches, caissons, conduits, pipe lines, roads and all operations pertaining thereto; the moving of buildings and other structures, and to the construction, alteration, repair, or removal of wharfs, docks, bridges, culverts, trestles, piers, abutments or any other construction, alteration, repair or removal work related thereto.

**Contractor** - A third-party that is providing construction, maintenance, service, and/or repair work for the UW.

**Crane** - A machine for lifting and lowering a load and moving it horizontally, with the hoisting mechanism and integral part of the machine. Cranes, whether fixed or mobile, are driven manually or by power.

**Designated Person** - Selected or assigned by the employer or the employer's representative as qualified to perform specific duties.

**Emergency stop switch** - A manually or automatically operated electric switch to cut off electric power independently of the regular operating controls.

**Employee** - Includes University personnel (as defined in [Administrative Policy Statement 40.1](#)), faculty, staff, paid student workers, and contracted employees that are under the direct daily supervision of UW personnel.



**Gantry Crane** - A crane similar to an overhead crane except that the bridge for carrying the trolley or trolleys is rigidly supported on two or more legs running on fixed rails or another runway.

**Hoist** - An apparatus which may be a part of a crane, exerting a force for lifting or lowering.

**Hoist chain** - The load bearing chain in a hoist.

**Hoist motion** - The motion of a crane which raises and lowers a load.

**Hoist** - An apparatus which may be a part of a crane, exerting a force for lifting or lowering.

**Jib boom** - A horizontal cantilever track for supporting the carrier.

**Job Hazard Analysis (JHA)** - A JHA is a method for identifying and evaluating hazards associated with tasks (steps) with a specific job or activity and eliminating or mitigating them prior to conducting work.

**Overhead Crane** - A crane with a movable bridge carrying a movable or fixed hoisting mechanism and traveling on an overhead fixed runway structure.

**Pendant** - Control suspended from an electric hoist.

**Qualified Person** - One who, by possession of a recognized degree, certificate, or professional standing, or who by extensive knowledge, training, and experience, has successfully demonstrated their ability to solve or resolve problems relating to the subject matter, the work, or the project.

**Rated Load** - The maximum load for which a crane or individual hoist is designed and built by the manufacturer and shown on the equipment nameplate(s). Sometimes referred to as maximum load capacity or rated capacity.

**Reeving** - To pass (a rope or similar item) through a hole, ring, or similar item.

**Rope** - Refers to a wire rope unless otherwise specified.

**Safe Working Load (SWL)** - Is the maximum load capacity or maximum working load of the rigging equipment without fear of failure. The SWL is calculated by dividing the minimum breaking load by a safety factor of 5.

**Shock-Loading:** Sudden increase in the apparent weight of the load. The crane, hoist and accessories are designed to carry a gradual load and not designed to withstand a sudden increase or decrease in the weight of the load.

**Sling** - An assembly which connects the load to the material handling equipment.

**Trolley** - The unit which travels on the bridge rails and carries the hoisting mechanism.



# APPENDIX B: OVERHEAD CRANE AND HOIST INSPECTION CHECKLIST

---

View the most recent accessible version of the [Overhead Crane and Hoist Inspection Checklist](#) on the EH&S website.

## Overhead Crane and Hoist Inspection Checklist

Per the regulation [WAC 296-24-23519](#), overhead cranes and hoists must be inspected before use. Inspection procedures for overhead cranes are divided into two general classifications, based on the interval at which inspection should be performed: **frequent** and **periodic**.

This Overhead Cranes/Hoists Inspection Checklist contains **frequent** inspection requirements, **periodic** inspection requirements, and wire rope/chain inspection information for overhead cranes and hoists.

- Complete a **pre-operation inspection** using the frequent checklist items on the inspection checklist prior to crane/hoist use.
- The operator or other designated person conducts the inspection.
- Cranes/Hoists in regular use must have a documented inspection checklist at least **monthly** using the **frequent inspection**.
  - Cranes/Hoists idle for *1 to 6 months* must have a documented **frequent inspection** before use.
  - Cranes/Hoists idle for *more than 6 months* must have a documented **periodic inspection** before use (refer to instructions below).
- Deficiencies identified during the pre-operation inspection must be addressed before use.
- Inspectors must sign and date the inspection log or checklist to confirm completion.
- Inspectors must keep a record of all frequent and periodic inspections for one year.

**Periodic inspections** must be completed by qualified personnel. Overhead cranes and hoists in regular use must have a periodic inspection at least **annually**. Refer to the [Cranes, Hoists and Rigging Safety webpage](#) on the EH&S website for more information on periodic inspections and a list of Seattle area crane inspection firms with qualified personnel.

Any overhead cranes/hoists with deficiencies identified during an inspection must be tagged “out of service,” repaired, or corrected before use. All active cranes should have regular preventive maintenance performed in accordance with the manufacturer’s recommendations.

### Overhead Crane and Hoist Inspection Checklist

Type of crane: \_\_\_\_\_ Crane capacity (tons): \_\_\_\_\_

Location: \_\_\_\_\_ Hoist capacity (tons): \_\_\_\_\_

Item	Inspection Frequency: * = required		Part of Crane/Hoist to be Inspected	Inspect for:	Equipment Condition:		
	Frequent (once per month)	Periodic (more than 6 months)			OK	Faulty	N/A
1	*	*	Controls and operating mechanisms (includes pendant)	Improper adjustments, excessive wear, and unusual noises; ensure all controls function properly and each performs as marked.	<input type="checkbox"/>	<input type="checkbox"/>	<input type="checkbox"/>
2	*	*	Lines, Tanks, Valves, and Other Parts in Air or Hydraulic Systems	Deterioration or leakage	<input type="checkbox"/>	<input type="checkbox"/>	<input type="checkbox"/>
3	*	*	Hooks	Deterioration or cracks; hooks must be thrown away immediately if: a) Throat opening is more than 15% in excess of normal throat opening or; b) Hook tip is more than 10° twist from the plane of the unbent hook. c) safety latch	<input type="checkbox"/>	<input type="checkbox"/>	<input type="checkbox"/>
4	*	*	Chains and End Connections	Excessive wear, twist, stretch or distortion of links beyond manufacturer's specs	<input type="checkbox"/>	<input type="checkbox"/>	<input type="checkbox"/>
5	*	*	Safety Devices, Belt-Chain Gear Guards	Improperly adjusted, missing, or broken	<input type="checkbox"/>	<input type="checkbox"/>	<input type="checkbox"/>
6	*	*	Outriggers	Locking devices and general condition foundation and cribbing	<input type="checkbox"/>	<input type="checkbox"/>	<input type="checkbox"/>
7	*	*	Fire Extinguisher (readily accessible)	Missing or discharged	<input type="checkbox"/>	<input type="checkbox"/>	<input type="checkbox"/>
8	*	*	Pre-operational test; upper limit switch operating properly	Verify proper operation of the upper limit and lower limit devices under no-load conditions. Listen for unusual sounds when operating.	<input type="checkbox"/>	<input type="checkbox"/>	<input type="checkbox"/>
9		*	Boom and Crane Structure	Bent or twisted parts broken welds, cracks, dents, deformation, heavy rust	<input type="checkbox"/>	<input type="checkbox"/>	<input type="checkbox"/>
10		*	Bolts and Rivets	Loose or missing	<input type="checkbox"/>	<input type="checkbox"/>	<input type="checkbox"/>
11		*	Sheaves and Drums	Excessive wear, cracks	<input type="checkbox"/>	<input type="checkbox"/>	<input type="checkbox"/>
12		*	Pins, Bearings, Shafts, Rollers,	Excessive wear, distortion, cracks	<input type="checkbox"/>	<input type="checkbox"/>	<input type="checkbox"/>

Item	Inspection Frequency: * = required		Part of Crane/Hoist to be Inspected	Inspect for:	Equipment Condition:		
	Frequent (once per month)	Periodic (more than 6 months)			OK	Faulty	N/A
			Gears, Locking and Clamping Devices				
13		*	Brake System	Excessive wear or improper operation of brake system parts	<input type="checkbox"/>	<input type="checkbox"/>	<input type="checkbox"/>
14		*	Indicators (Load, Wind, Boom Angle)	Significant inaccuracy	<input type="checkbox"/>	<input type="checkbox"/>	<input type="checkbox"/>
15		*	Chain Drives, Sprockets	Excessive wear	<input type="checkbox"/>	<input type="checkbox"/>	<input type="checkbox"/>
16		*	Electrical Apparatus	Deterioration of wiring, worn or dirty controls, poor connections	<input type="checkbox"/>	<input type="checkbox"/>	<input type="checkbox"/>

### Wire Rope/Chain Inspection Checklist

Item	Inspection Frequency: * = required		Part of Crane/Hoist to be Inspected	Inspect for:	Equipment Condition:		
	Frequent (once per month)	Periodic (longer than 6 months)			OK	Faulty	N/A
1	*	*	Reduction in diameter	Remove wire rope from service if reduction from nominal diameter is greater than 5%.	<input type="checkbox"/>	<input type="checkbox"/>	<input type="checkbox"/>
2	*	*	Broken wires	4 broken wires in 1 strand, or 12 broken wires in all strands	<input type="checkbox"/>	<input type="checkbox"/>	<input type="checkbox"/>
3	*	*	Flat spots	On outer wires where wires <2/3 normal thickness	<input type="checkbox"/>	<input type="checkbox"/>	<input type="checkbox"/>
4	*	*	Distortion – Core failure	Severe kinking, crushing bird caging, displaced wires	<input type="checkbox"/>	<input type="checkbox"/>	<input type="checkbox"/>
5	*	*	Chain links Wear/distorted	Gouges, nicks, corrosion, weld spatter	<input type="checkbox"/>	<input type="checkbox"/>	<input type="checkbox"/>
6	*	*	Chain links stretched	Chain length > 1.5 – 2.5 % longer (powered versus manual) than unused	<input type="checkbox"/>	<input type="checkbox"/>	<input type="checkbox"/>
7	*	*	Heat damage	From any cause	<input type="checkbox"/>	<input type="checkbox"/>	<input type="checkbox"/>
8	*	*	Wires at end connections	Corroded or broken wires at end connections	<input type="checkbox"/>	<input type="checkbox"/>	<input type="checkbox"/>
9	*	*	End connections	Corroded, cracked, bent, worn or improperly applied end connections	<input type="checkbox"/>	<input type="checkbox"/>	<input type="checkbox"/>
10	*	*	Wire rope/chain operation	Not noisy; no binding and feeds smoothly; chains are lubricated per original equipment manufacturer.	<input type="checkbox"/>	<input type="checkbox"/>	<input type="checkbox"/>

Inspector notes:



## APPENDIX C: RIGGING EQUIPMENT INSPECTION CHECKLIST

---

### Rigging Equipment Inspection Checklist

This Rigging Equipment Inspection Checklist includes inspection requirements for wire rope rigging, alloy steel chain slings, metal mesh slings, natural and synthetic fiber rope slings, and synthetic wire slings. **Each day** before being used, you must ensure that the sling and all fastenings and attachments are inspected for damage or defects by a competent person designated by the employer. Additional inspections must be performed during sling use, where service conditions warrant, such as high heat temperatures. You must immediately remove damaged or defective slings from service. For more details on what to look for during the inspection, refer to [Appendix E](#).

Document rigging equipment inspections at least annually. Keep records on file for one year.

Your name:	Date/time:
Location:	
Department:	

View the most recent accessible version of the [Rigging Equipment Inspection Checklist](#) on the EH&S website.

# Rigging Equipment Inspection Checklist

This Rigging Equipment Inspection Checklist includes inspection requirements for all sling types (i.e., wire rope, alloy steel chain, metal mesh, natural and synthetic fiber rope, and synthetic wire) and hardware fastening components (e.g., shackles, bolts, swivels, hooks, etc.).

*Instructions:* **Each day** before being used, you must ensure that the sling and all fastenings and attachments are inspected for damage or defects by a competent person. Additional inspections must be performed during sling use where service conditions warrant, such as high heat temperatures. You must immediately remove damaged or defective slings from service.

Document rigging equipment inspections at least annually. Keep records on file for one year.

Your name: \_\_\_\_\_ Date/time: \_\_\_\_\_

Location: \_\_\_\_\_

Unit/department: \_\_\_\_\_

## Wire Rope Sling/Rigging Inspection

If applicable, please complete the table below. If *not* applicable, check this box .

Slings shall have a manufacturer's label showing the rated capacity. Do *not* exceed rated capacity.

Remove from service if <i>any</i> of the following apply:	Yes	No
10 randomly distributed <b>broken wires</b> in 1 rope lay, or 5 broken wires in 1 strand in 1 rope lay (refer to Figure 1 below)	<input type="checkbox"/>	<input type="checkbox"/>
<b>Wear or scraping</b> of 1/3 <sup>rd</sup> the original diameter of outside individual wires	<input type="checkbox"/>	<input type="checkbox"/>
<b>Distortion</b> such as kinking, crushing, bird caging, displace wires	<input type="checkbox"/>	<input type="checkbox"/>
Evidence of <b>heat damage</b> from any cause	<input type="checkbox"/>	<input type="checkbox"/>
<b>End attachments</b> that are cracked, deformed, or worn	<input type="checkbox"/>	<input type="checkbox"/>
<b>Hooks</b> have been opened >15% of normal throat opening or twisted >10 degrees	<input type="checkbox"/>	<input type="checkbox"/>

### Additional Information:

1. Use sling protection and avoid load slippage.
2. Don't choke on fittings, avoid pinch points.
3. Don't place sling eye on large hook.

[WAC 296-24-29425](http://www.wa.gov/wac/296-24-29425)

Figure 1: Wire rope components.  
Created by Phillip Toone, OSHA DTSEM/SLTC

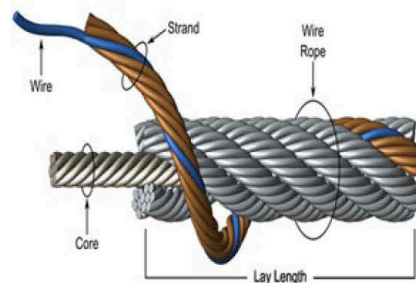



## Alloy Steel Chain Slings

If applicable, please complete the table below. If *not* applicable, check this box .

Do not exceed rated capacity. Slings shall have a manufacturer’s label with size, grade, rated capacity, and reach.

Remove from service and discard if <i>any</i> of the following apply:	Yes	No
Sling has been <b>heated</b> above 1000 °F.	<input type="checkbox"/>	<input type="checkbox"/>
<b>Cracked or deformed</b> master links, couplings, or other components	<input type="checkbox"/>	<input type="checkbox"/>
<b>Hooks</b> have been opened >15% of normal throat opening or twisted >10 degrees.	<input type="checkbox"/>	<input type="checkbox"/>

### Additional information:

1. Makeshift links or fasteners made from bolts or rods must not be used.
2. Mechanical coupling or low carbon steel repair links must not be used to repair broken lengths of chains.
3. Prior to use, all welded or mechanical components of new slings must be roof tested by the Manufacturer to twice the rated load. Proof test certificates can be requested of the manufacturer, if needed.
4. Latches on hooks must “seat properly, rotate freely, and show no permanent distortion.”

[WAC 296-24-29423](#)

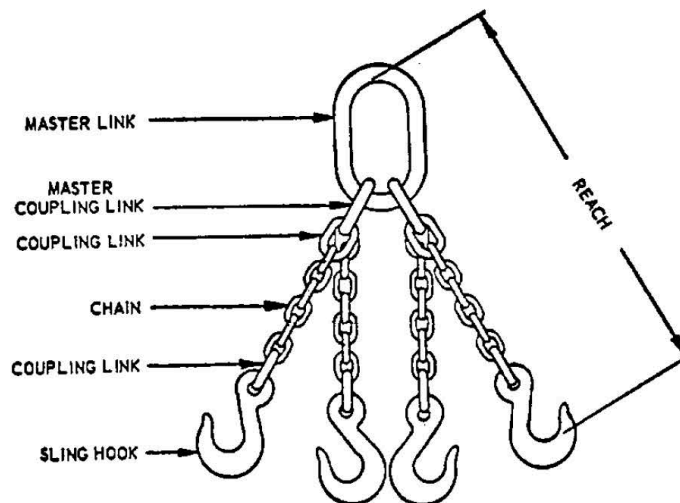

**FIG. N-184-3 MAJOR COMPONENTS OF A QUADRUPLE SLING.**

Figure 2: Multi-leg sling (osha.gov 1910.184)

### Synthetic Web Slings

If applicable, please complete the table below. If *not* applicable, check this box .

Slings shall have a manufacturer’s label showing the rated capacity. Do not exceed rated capacity.

Do not use nylon web or aluminum fittings near acid. Do not use polyester web around caustics.

Stitching is the only acceptable method to attach end fittings and form eyes.

Remove from service if <i>any</i> of the following apply:	Yes	No
Acid or caustic burns	<input type="checkbox"/>	<input type="checkbox"/>
Melting or charring of any part of the sling surface	<input type="checkbox"/>	<input type="checkbox"/>
Snags, punctures, tears, or cuts	<input type="checkbox"/>	<input type="checkbox"/>
Broken or worn stitches	<input type="checkbox"/>	<input type="checkbox"/>
Distortion of fittings	<input type="checkbox"/>	<input type="checkbox"/>

**Additional Information:**

1. Use sling protection between edges and sling.
2. Do not shorten or lengthen using knots.

[WAC 296-24-29431](#)



Figure 3: Synthetic slings  
Source: mazzellacompanies.com



### Metal Mesh Slings

If applicable, please complete the table below. If *not* applicable, check this box .

Remove from service if <i>any</i> of the following apply:	Yes	No
A <b>broken weld</b> or broke brazed joint along the sling edge	<input type="checkbox"/>	<input type="checkbox"/>
Lack of <b>flexibility</b> due to distortion of the fabric	<input type="checkbox"/>	<input type="checkbox"/>
<b>Distortion</b> of the female handle so that the width of the eye is decreased more than 10%	<input type="checkbox"/>	<input type="checkbox"/>
<b>Distortion</b> of either handle so that the width of the eye is decreased more than 10%	<input type="checkbox"/>	<input type="checkbox"/>
A 15% reduction of the original cross-sectional area of metal at any point around the handle eye	<input type="checkbox"/>	<input type="checkbox"/>
<b>Distortion</b> of either handle out of its plane	<input type="checkbox"/>	<input type="checkbox"/>

[WAC 296-24-29427](#)



Figure 4: Wire mesh slings  
Source: mazzellacompanies.com

### Natural and Synthetic Fiber Rope Slings

If applicable, please complete the table below. If *not* applicable, check this box .

**Repairs:** You must only use fiber rope slings made from new rope. Use of repaired or recondition fiber rope slings is prohibited.

Remove from service if <i>any</i> of the following apply:	Yes	No
<b>Abnormal</b> wear	<input type="checkbox"/>	<input type="checkbox"/>
<b>Powdered fiber</b> between strands	<input type="checkbox"/>	<input type="checkbox"/>
<b>Broken</b> or cut fibers	<input type="checkbox"/>	<input type="checkbox"/>
<b>Variations</b> in the size or roundness of strands	<input type="checkbox"/>	<input type="checkbox"/>
<b>Discoloration</b> or rotting	<input type="checkbox"/>	<input type="checkbox"/>
<b>Distortion</b> of hardware in the sling	<input type="checkbox"/>	<input type="checkbox"/>

[WAC 296-24-29429](#)



Figure 5: [Synthetic fiber rope sling](#)  
Source: amazon.com

### Rigging Accessories - Shackles, swivels, and hoist rings

If applicable, please complete the table below. If not applicable, check this box .

Remove from service if any of the following apply:	Yes	No
Indications of <b>heat damage</b> , including weld spatter or arc strikes	<input type="checkbox"/>	<input type="checkbox"/>
Excessive <b>pitting</b> or <b>corrosion</b>	<input type="checkbox"/>	<input type="checkbox"/>
Excessive <b>nicks</b> or <b>gouges</b>	<input type="checkbox"/>	<input type="checkbox"/>
<b>10% reduction</b> of the original (or catalog) dimension at any point	<input type="checkbox"/>	<input type="checkbox"/>
Excessive thread <b>damage</b> or <b>wear</b>	<input type="checkbox"/>	<input type="checkbox"/>
On <b>shackles</b> , also inspect for incomplete <b>pin engagement</b>	<input type="checkbox"/>	<input type="checkbox"/>
On <b>swivels and hoist rings</b> , check for lack of ability to freely rotate or pivot	<input type="checkbox"/>	<input type="checkbox"/>

[WAC 296-155-55600](http://www.wa.gov/wac/default.aspx?cite=296-155-55600)



Figure 7: Hardware fasteners; swivels, hooks  
Source: mazzellacompanies.com



Figure 6: Various shackles  
Source: mazzellacompanies.com

# APPENDIX D: CRANE/HOIST AND RIGGING CRITICAL LIFT PLAN

View the most recent accessible version of the [Crane/Hoist and Rigging Critical Lift Plan](#) on the EH&S website.

ENVIRONMENTAL HEALTH & SAFETY

UNIVERSITY of WASHINGTON

## CRANE/HOIST AND RIGGING CRITICAL LIFT PLAN

Lift Begin Date: \_\_\_\_\_ Lift End Date: \_\_\_\_\_ Location of Lift: \_\_\_\_\_

Lift Description: \_\_\_\_\_

Designated Lift Lead: \_\_\_\_\_ Signature: \_\_\_\_\_ Date: \_\_\_\_\_

Authorized Lifters (*designated by Lead, understand Lift Plan requirements and their role in the lift*):

Name: \_\_\_\_\_ Signature: \_\_\_\_\_ Date: \_\_\_\_\_

Name: \_\_\_\_\_ Signature: \_\_\_\_\_ Date: \_\_\_\_\_

Name: \_\_\_\_\_ Signature: \_\_\_\_\_ Date: \_\_\_\_\_

### CHARACTERIZE THE LOAD(S)

This plan covers:  Single Load Only

Variety of similar loads (*enter dimensions and weight of largest load covered by the plan*)

Length: \_\_\_\_\_ Width: \_\_\_\_\_ Height: \_\_\_\_\_ Diameter: \_\_\_\_\_

Load Weight (lbs.): \_\_\_\_\_ Weight determination (choose one):

Marked on load  Weighed  Estimated  Other (describe): \_\_\_\_\_

If calculated, weight calculated by (initials): \_\_\_\_\_ *Attach calculations.*

### CHARACTERIZE THE TASK

**(Include directions for lifting, rotation, flipping, speeds, and travel.)**

1. \_\_\_\_\_
2. \_\_\_\_\_
3. \_\_\_\_\_
4. \_\_\_\_\_
5. \_\_\_\_\_

### PLAN THE RIGGING

Define specific controls. On a sketch or photo (next page), show how the items will be rigged and the type of gear to be used:

- Show locations of shackles, hoists rings, spreader beams, slings, etc.
- Show attachment points (how rigging gear will be attached to the load).
- Show where padding of sharp edges are necessary.
- Provide the weight of heavy equipment such as lifter or spreader beam.
- Show proper orientation of eyebolts.
- Indicate the center of gravity (horizontal and vertical).



**ENVIRONMENTAL HEALTH & SAFETY**

UNIVERSITY of WASHINGTON

**Sketch of load handling method:** *(Include all information required to determine that the load is properly rigged, and that appropriate rigging gear is selected. Include, as applicable, sling angles, eye bolt orientation, padding points, center of gravity, type of sling hitch, and any other pertinent information.)*















*Note: Annotate sling tensions on rigging components.*

**Characterize the attachment points:**

- Manufacturer-provided lift point
- Sling in choker hitch
- Sling in basket hitch
- Sling in vertical hitch
- Threaded hole (eyebolt or hoist ring)
- Other (describe): \_\_\_\_\_



## APPENDIX E: RIGGING INSPECTION DETAILS

EQUIPMENT	EXAMPLES						INSPECTION CHECKS
<p><b>Alloy Steel Chain</b></p> 	<p><b>Wear</b></p> 	<p><b>Bent Links</b></p> 	<p><b>Hinge</b></p> 	<p><b>Stretch</b></p> 	<p><b>Gouge</b></p> 	<p><b>Cut</b></p> 	<p>Check overall length to see if it matches up with the length on the tag. If a sling is shorter or longer (considering allowable tolerances) than the length on the tag, the sling must be taken out of service.</p> <p>Check for cracked or deformed master links (refer to image): Stretched, bent, cut or worn, bent links, hinge, stretch, gouge, cut, weld, twisted links, illegible tag, make shift, damaged, DIY repairs.</p> <p>Check for hooks open &gt; 15%.</p> <p>Check for hooks twisted more than 10 degrees from the plane of the unbent hook.</p>
	<p><b>Weld</b></p> 	<p><b>Twisted Links</b></p> 	<p><b>Illegible Tag</b></p> 	<p><b>Make Shift</b></p> 	<p><b>Damaged</b></p> 	<p><b>DIY Repairs</b></p> 	





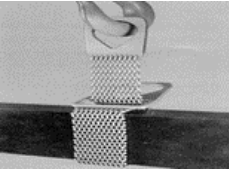
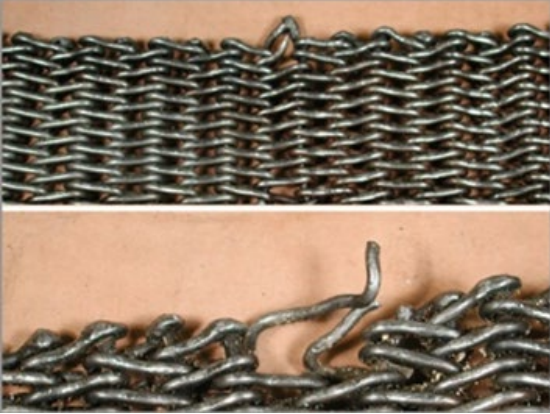

EQUIPMENT	EXAMPLES	INSPECTION CHECKS
<p><b>Wire rope</b></p> 		<p>Check for the following (refer to image):</p> <ul style="list-style-type: none"> <li>- Ten randomly distributed broken wires in one rope lay, or five broken wires in one strand in one rope lay</li> <li>- Core failure: kinking, crushing, or birdcaging</li> <li>- Cracked, deformed, or worn wires</li> <li>- Heat damage or corrosion</li> <li>- Severe wear, doglegs, broken wires, damaged fittings, illegible tag/ID</li> </ul>

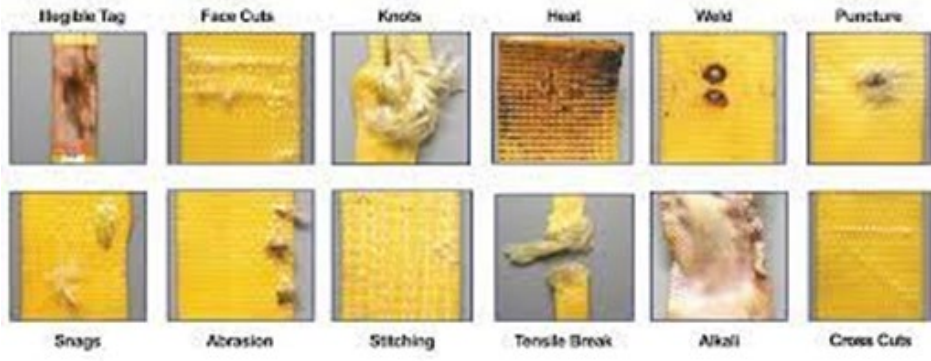

EQUIPMENT	EXAMPLES	INSPECTION CHECKS
<p><b>Wire mesh</b></p> 		<p>Verify none of the following are present (refer to image):</p> <ul style="list-style-type: none"> <li>- A broken weld or broken brazed joint along the sling edge</li> <li>- Reduction in wire diameter of 25% due to abrasion or 15% due to corrosion</li> <li>- Lack of flexibility due to distortion of the fabric</li> <li>- Distortion of the female handle so that the depth of the slot is increased more than 10%</li> <li>- Distortion of either handle so that the width of the eye is decreased more than 10%</li> <li>- A 15% reduction of the original cross-sectional area of metal at any point around the handle eye</li> <li>- Distortion of either handle out of its plane</li> </ul>





EQUIPMENT	EXAMPLES	INSPECTION CHECKS
<p><b>Synthetic slings</b></p> 		<p>Verify none of the following are present (refer to image):</p> <ul style="list-style-type: none"> <li>- Acid or caustic burns (alkali)</li> <li>- Melting or charring of any part of the sling surface (heat)</li> <li>- Snags, punctures, tears or cuts (puncture, cross cuts)</li> <li>- Broken or worn stitches (abrasion, tensile break, stitching)</li> <li>- Distortion of fittings</li> <li>- Illegible tag</li> <li>-Knots</li> </ul>

EQUIPMENT	EXAMPLES	INSPECTION CHECKS
<p><b>Shackles</b></p> 	 <p>Incorrect Pin</p> <p>Bent, twisted, distorted, stretched, elongated body &amp; pin</p> <p>Material Reduction</p> <p>Cracked / Broken Body</p> <p>Excessive Corrosion</p>	<p>Verify none of the following are present (refer to image):</p> <ul style="list-style-type: none"> <li>- Missing or illegible manufacturer’s name or trademark and/or rated load identification</li> <li>- Indications of heat damage including weld spatter or arc strikes</li> <li>- Excessive pitting or corrosion</li> <li>- Bent, twisted, distorted, stretched, elongated, cracked, or broken load-bearing components</li> <li>- Excessive nicks or gouges</li> <li>- A 10% reduction of the original or catalog dimension at any point around the body or pin</li> <li>- Incomplete pin engagement</li> <li>- Incorrect pin</li> <li>- Excessive thread damage</li> <li>- Evidence of unauthorized welding</li> <li>- Other conditions, including visible damage, that cause doubt as to the continued use of the shackle</li> </ul>

EQUIPMENT	EXAMPLES	INSPECTION CHECKS
<p><b>Eye bolts</b></p> 	<p><b>DAMAGE EYE BOLT</b></p> 	<p>Visually inspect the hole to ensure that there has been no deformation.</p> <p>Check the condition of the threads in the hole to ensure that the eyebolt will secure, and the shoulder can be brought down snug.</p> <p>Ensure that the shank of the eyebolt is not undercut and is smoothly radiused into the plane of the shoulder or the contour of the ring for non-shouldered eyebolts.</p> <p>Remove from service eyebolts that are cracked, bent, or have damaged threads (refer to image).</p>

EQUIPMENT	EXAMPLE	INSPECTION CHECKS
<p><b>Swivel hoist rings</b></p> 		<p>Ensure free movement of bail and swivel.</p> <p>Inspect the hole to ensure that there has been no deformation.</p> <p>Check the condition of the threads in the hole to ensure that the hoist ring will secure, and the bushing can be brought down for a snug fit.</p> <p>Remove from service hoist rings that are cracked, bent, have damaged threads, or do not operate freely (refer to image).</p>

EQUIPMENT	EXAMPLE	INSPECTION CHECKS
<p><b>Turnbuckles</b></p> 		<p>Turnbuckles must be inspected for damage before each use. Damaged threads, jamb nuts, or bent frame members make the unit unsuitable for use.</p>

# APPENDIX F: CRANE OPERATOR ASSESSMENT FORM

View the most recent accessible version of the [Crane Operator Assessment Form](#) on the EH&S website.

ENVIRONMENTAL HEALTH & SAFETY  
UNIVERSITY of WASHINGTON

## CRANE OPERATOR ASSESSMENT FORM

**Employee:** \_\_\_\_\_  
(Print name)

**Competent Trainer:** \_\_\_\_\_ **Date:** \_\_\_\_\_  
(Print name)

**This document confirms the assessment of the above-named employee to perform:**  
(Check all that apply. Attach an additional page if more space is needed.)

- Operate/inspect overhead cranes and hoists within their department/unit/organization
- Inspect rigging and rig loads to be suspended within their department/unit/organization
- Other: \_\_\_\_\_

**This designation is based on evidence of safe performance of all duties related to crane/hoist operation and verification by another "Competent Person" through**  
(Check all that apply.)

- Training:** Appropriate training records (including any skill checks or tests) are attached.
- Experience:** This employee has been safely performing and has demonstrated skill in crane/hoist operation for \_\_\_\_ years (minimum of five years).
- Instruction:** This employee has received on the job instruction from me or another employee who is competent, has observed this employee's work while performing this operation, and confirms that the employee has the knowledge to perform crane/hoist work safely.

Below are signature(s) of responsible person(s) verifying training, experience and/or providing instruction:

**Supervisor Signature:** \_\_\_\_\_ **Date:** \_\_\_\_\_

**Competent Trainer Signature:** \_\_\_\_\_ **Date:** \_\_\_\_\_

**Employee Signature:** \_\_\_\_\_ **Date:** \_\_\_\_\_

cc: EH&S; Supervisor file; Employee and their personnel file



# APPENDIX G: SUPPLEMENTAL CRANE, HOIST AND RIGGING PROGRAM TEMPLATE

---

View the most recent accessible version of the [Supplemental Crane, Hoist and Rigging Program Template](#) on the EH&S website.

UNIVERSITY of WASHINGTON

**[Unit/department/organization name]**  
SUPPLEMENTAL CRANE, HOIST, AND RIGGING  
PROGRAM

Approved By:  
[Name], [Title]

[SEPTEMBER 2023]



UNIVERSITY of WASHINGTON

TABLE OF CONTENTS

Table of contents..... 2  
Purpose ..... 3  
Scope ..... 3  
Program Management..... 3  
    Responsibilities..... 3  
    Equipment inventory ..... 4  
    Unit specific equipment operating procedures..... 5  
Equipment Inspections, Maintenance, and Testing ..... 5  
    Frequent and Periodic Inspections..... 5  
    Maintenance and Testing..... 6  
Training ..... 6  
Appendix A..... 7



## UNIVERSITY of WASHINGTON

**Instructions for the preparer:** Complete this template by filling in the data entry boxes with information relevant to your unit. This [Supplemental Crane, Hoist and Rigging Program Template](#) can be modified as needed to address any/all potential hazards. A draft of this program should be reviewed by appropriate stakeholders in your unit and approved by your unit leader before distributing it to personnel. Review of your unit's Supplemental Program by UW Environmental Health & Safety (EH&S) is not required; however, EH&S can provide consultation as needed by contacting [ehsdept@uw.edu](mailto:ehsdept@uw.edu). Visit the [Cranes, Hoists and Rigging Safety webpage](#) on the EH&S website at [www.ehs.washington.edu](http://www.ehs.washington.edu) for more information and to download the UW Crane, Hoist, and Rigging Program Manual.

The term "unit" represents the entities supported by this plan. It applies to all schools, units, units, and organizations within the University, excluding the University of Washington medical or healthcare facilities. The term "personnel" will include all staff, faculty, students, and volunteers in paid positions (permanent, part-time, or seasonal) and all employment groups described in [Administrative Policy Statement 40.1](#).

### PURPOSE

This document is the [Unit/unit/organization name] Supplemental Crane, Hoist and Rigging Program ("Supplemental Program") and addresses unit-specific hazards and safety guidance to ensure the safety of personnel and prevent personal injury or illness that could result during the use of overhead cranes, hoists, and the rigging of loads.

### SCOPE

The [UW Crane, Hoist, and Rigging Program Manual](#) and this Supplemental Program cover all unit job titles or roles that will be assigned the responsibility of overseeing the management of cranes, hoist, and rigging equipment, which includes ensuring the equipment is inspected and maintained in accordance with the requirements in the UW Crane, Hoist and Rigging Program Manual and providing training to personnel that have been identified as crane and rigging operators. The locations covered in this program include, but are not limited to:

1. Insert location 1
2. Insert location 2
3. Add additional locations as needed

### PROGRAM MANAGEMENT

#### RESPONSIBILITIES

The unit has identified an employee to be the unit crane/hoist competent person that is responsible for overseeing the crane/hoist unit-specific program and providing training for crane/hoist operators.

## UNIVERSITY of WASHINGTON

Unit crane/hoist competent person: First and Last Name

The unit has identified crane/hoist operators and ensured they have completed training.

A list identifying the unit crane/hoist program competent person and personnel who are designated as crane/hoist operators shall be maintained and kept current. *Refer to the Appendix below for an example log.*

### EQUIPMENT INVENTORY

Provide a list of all cranes and hoist equipment, location, and status (operational or out of service).

**Table 1: Crane/Hoist Equipment Inventory**

Location (Building and Room No. or Area)	List each type of crane and hoist	Maximum Load Capacity (Rated Load in pounds, tons)	Type of Control (manual, pendant, remote)	Status (Operational or Out of Service)
Click or tap here to enter text.	Choose an item.	Click or tap here to enter text.	Click or tap here to enter text.	Choose an item.
Click or tap here to enter text.	Click or tap here to enter text.	Click or tap here to enter text.	Click or tap here to enter text.	Choose an item.
Click or tap here to enter text.	Click or tap here to enter text.	Click or tap here to enter text.	Click or tap here to enter text.	Choose an item.
Click or tap here to enter text.	Click or tap here to enter text.	Click or tap here to enter text.	Click or tap here to enter text.	Choose an item.
Click or tap here to enter text.	Click or tap here to enter text.	Click or tap here to enter text.	Click or tap here to enter text.	Choose an item.
Click or tap here to enter text.	Click or tap here to enter text.	Click or tap here to enter text.	Click or tap here to enter text.	Choose an item.
Click or tap here to enter text.	Click or tap here to enter text.	Click or tap here to enter text.	Click or tap here to enter text.	Choose an item.

List the location(s) where the rigging equipment is stored.

Location 1

Location 2

Additional Locations

## UNIVERSITY of WASHINGTON

### UNIT-SPECIFIC EQUIPMENT OPERATING PROCEDURES

Each unit must develop specific operating procedures (SOP) for different cranes/hoists used for material handling. The SOP must include safe operating procedures and identify the safeguards in place to control hazards, including identifying any required personal protective equipment. An example [SOP template](#) on the EH&S website can be used and modified to capture the instructions for the use, inspection and maintenance of the crane/hoist and rigging equipment. Refer to the manufacturer's instructions and the UW Crane, Hoist and Rigging Program Manual to ensure safety requirements are incorporated into the SOP.

Job hazard analyses (JHAs) can be used in the place of SOPs. Refer to the [Job Hazard Analysis webpage](#) on the EH&S website for a template and instructions on how to develop a JHA.

SOPs and JHAs should be reviewed, at a minimum, every two years, to ensure that any changes to the equipment or operations have been evaluated and incorporated into the revised documents.

Describe how equipment specific procedures or JHAs are developed, managed, and updated.

**Table 2: Equipment specific SOPs or JHAs**

SOP/JHA title	Date	Version No.
Click or tap to enter title	Click or tap to enter a date.	Version No.
Click or tap to enter title	Click or tap to enter a date.	Version No.
Click or tap to enter title	Click or tap to enter a date.	Version No.
Click or tap to enter title	Click or tap to enter a date.	Version No.
Click or tap to enter title	Click or tap to enter a date.	Version No.
Click or tap to enter title	Click or tap to enter a date.	Version No.

### EQUIPMENT INSPECTIONS, MAINTENANCE, AND TESTING

#### Frequent and Periodic Inspections

All cranes, hoists and rigging equipment are inspected by the crane/hoist operators prior to use. Crane operators must document a monthly frequent inspection.

The [Overhead Cranes/Hoists Inspection Checklist](#) is located on the EH&S website *Click or tap here to enter location where the blank inspection form can be accessed.*

## UNIVERSITY of WASHINGTON

The [Rigging Equipment Inspection Checklist](#) is located on the EH&S website *Click or tap here to enter location where the blank inspection form can be accessed.*

Periodic Reviews are required to be **conducted annually** by a third-party or qualified person.

Provide the location where completed monthly and annual inspections are filed *Click or tap here to enter where completed inspections are files/stored.*

### **Maintenance and Testing**

Maintenance, service, and repairs must be performed in accordance with the Manufacturer's recommendations. Equipment with identified deficiencies must be taken out of service and corrected.

Provide a location where all maintenance and testing records are filed: *Click or tap here to enter where completed inspections are files/stored.*

Maintenance and testing records must be kept for six years.

### **TRAINING**

Describe the required training for crane, hoist, and rigging operators:

1. [Overhead and Gantry Crane Safety-Online](#) (on the EH&S website)
2. [Rigging Safety-Online](#) (on the EH&S website)
3. [Lockout-Tagout Refresher-online](#) – for affected personnel (on the EH&S website)
4. Click or tap here to enter additional equipment specific training (instructor led, etc.
5. Click or tap here to enter additional equipment specific training (instructor led, etc.
6. Click or tap here to enter additional equipment specific training (instructor led, etc.
7. Click or tap here to enter additional equipment specific training (instructor led, etc.
8. Click or tap here to enter additional equipment specific training (instructor led, etc.

*Track all crane operators completed training and certification evaluations for seven years.*

## UNIVERSITY of WASHINGTON

### APPENDIX A

*Example of log to maintain current record of the unit Crane/Hoist Program competent person and personnel who are crane/hoist operators.*

#### **Log of Unit Crane/Hoist competent person and Crane/Hoist operators**

[Unit/unit/organization name]

Date:

Name of competent person:

Name(s) of crane/hoist operators:

- 1.
- 2.
- 3.
- 4.
- 5.
- 6.
- 7.
- 8.
- 9.



## APPENDIX H:

### STANDARD HAND SIGNALS FOR CRANES

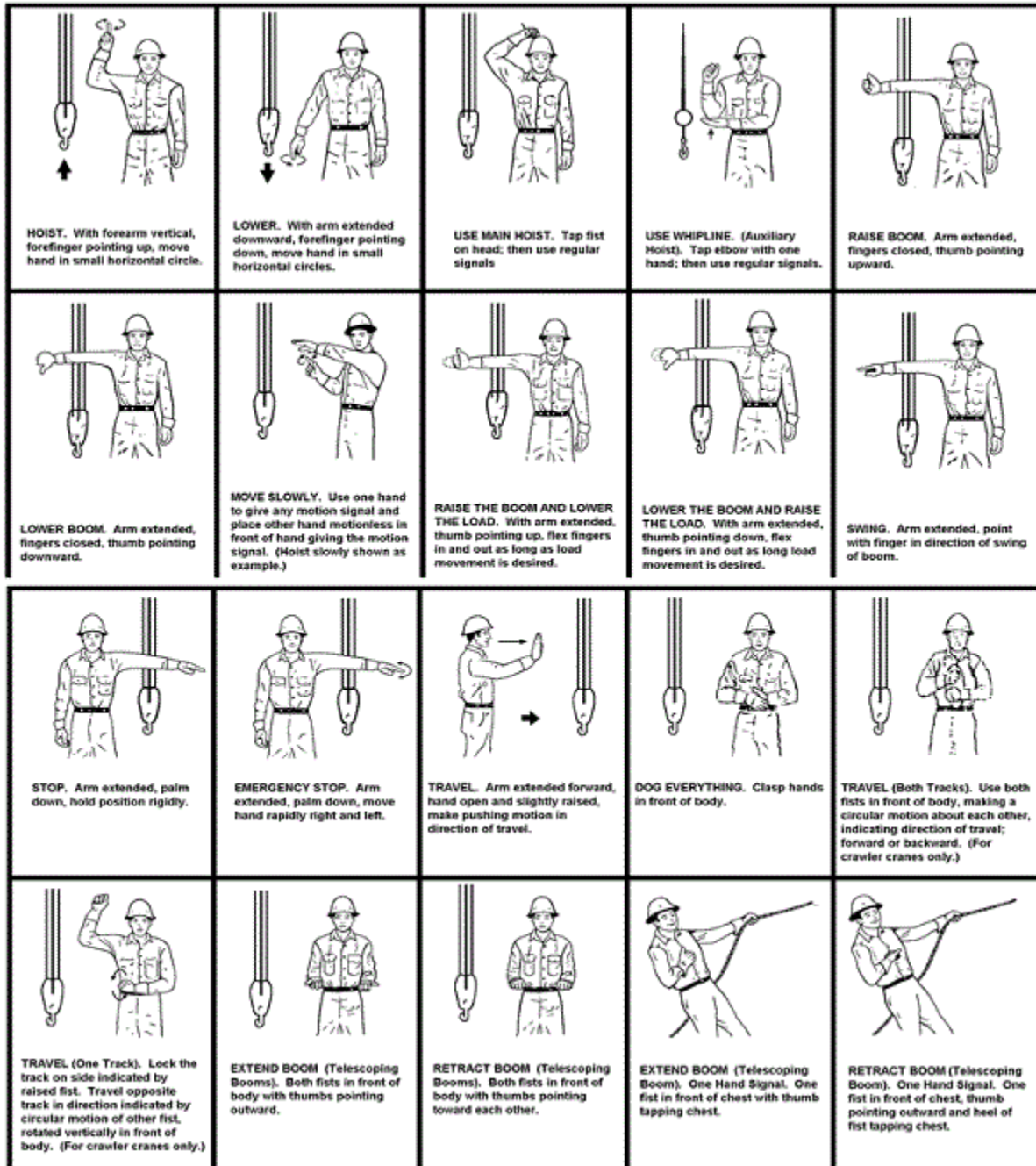

Figure 1: [WAC 296-24 Part D](#)

#### Hand signal descriptions

**HOIST:** With forearm vertical, forefinger pointing up, move hand in small horizontal circles.

**LOWER:** With arm extended downward, forefinger pointing down, move hand in small horizontal circles.

USE MAIN HOIST: Tap fist on head; then use regular signals.

USE WHIPLINE (Auxiliary Hoist): Tap elbow with one hand; then use regular signals.

RAISE BOOM: Arm extended, fingers closed, thumb pointing upward.

LOWER BOOM: Arm extended, fingers closed, thumb pointing downward.

MOVE SLOWLY: Use one hand to give any motion signal and place other hand motionless in front of hand giving the motion signal. (Hoist slowly as shown in the example.)

RAISE THE BOOM AND LOWER THE LOAD: With arm extended, thumb pointing up, flex fingers in and out as long as load movement is desired.

LOWER THE BOOM AND RAISE THE LOAD: With arm extended, thumb pointing down, flex fingers in and out as long as load movement is desired.

SWING: Arm extended, point with finger in direction of swing of boom.

STOP: Arm extended, palm down, move arm back and forth horizontally.

EMERGENCY STOP: Both arms extended, palms down, move arms back and forth horizontally.

TRAVEL: Arm extended forward, hand open and slightly raised, make pushing motion in direction of travel.

DOG EVERYTHING: Clasp hands in front of body.

TRAVEL (Both Tracks): Use both fists in front of body, making a circular motion about each other, indicating direction of travel, forward or backward (for land cranes only).

TRAVEL (One Track): Lock the track on side indicated by raised fist. Travel opposite track in direction indicated by circular motion of other fist, rotated vertically in front of body (for land cranes only).

EXTEND BOOM (Telescoping Booms): Both fists in front of body with thumbs pointing outward.

RETRACT BOOM (Telescoping Booms): Both fists in front of body with thumbs pointing in toward each other.

EXTEND BOOM (Telescoping Boom): One hand signal. One fist in front of chest with thumb tapping chest.

RETRACT BOOM (Telescoping Boom): One hand signal. One fist in front of chest, thumb pointing outward and heel of fist tapping chest.